



30V N-Channel MOSFET

General Description

The LPM9040A uses advanced trench technology to provide excellent $R_{DS(ON)}$ with low gate charge. This is an all purpose device that is suitable for use in a wide range of power conversion applications.

Features

- ◆ 100% EAS Guaranteed
- ◆ Green Device Available
- ◆ Super Low Gate Charge
- ◆ Excellent CdV/dt effect decline
- ◆ Advanced high cell density Trench technology

Order Information

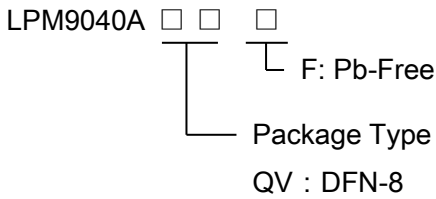

Applications

- ✧ Driver for Relay, Solenoid, Motor, LED etc.
- ✧ DC-DC converter circuit
- ✧ Power Switch
- ✧ Load Switch
- ✧ Charging

Pin Description

Pin Number	Pin Description
1	Source
2	
3	
4	Gate
5	Drain
6	
7	
8	

Pin Configurations

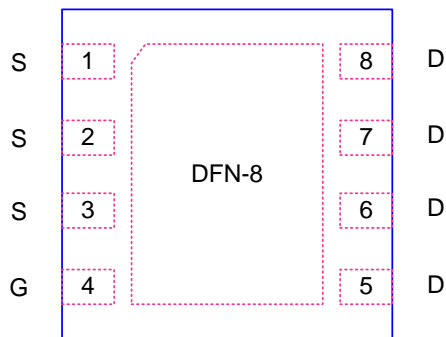

Marking Information

Part	Marking	Package	Shipping
LPM9040AQVF	LPS 9040A YWX	DFN-8	5K/REEL
Marking indication: Y:Production year W:Production week X:Production batch.			



Absolute Maximum Ratings

Parameter		Symbol	10 Sec	Steady State	Unit
Drain-Source Voltage		V_{DS}	30		V
Gate-Source Voltage		V_{GS}	± 20		
Continuous Drain Current	TA=25°C	I_D	13.5	10	A
	TA=70°C		10.8	8	
Pulsed Drain Current		I_{DM}	120		
Avalanche Current		I_{AR}	23		
Repetitive avalanche energy L=0.3mH		E_{AR}	79		mJ
Power Dissipation	TA=25°C	P_D	3.1	1.7	W
	TA=70°C		2.0	1.1	
Junction and Storage Temperature Range		T_J, T_{STG}	-55 to 150		°C

Thermal resistance ratings

Parameter		Symbol	TYP	MAX	Unit
Junction-to-Case Thermal Resistance	$t \leq 10s$	$R_{\theta JA}$	31	40	°C/W
Junction-to-Case Thermal Resistance	Steady State		59	75	°C/W
Maximum Junction-to-Lead	Steady State	$R_{\theta JL}$	16	24	°C/W



Electrical Characteristics

Electrical Characteristics (T_J=25°C unless otherwise noted)

Symbol	Parameter	Conditions	Min	Typ	Max	Units
STATIC PARAMETERS						
BV _{DSS}	Drain-Source Breakdown Voltage	I _D =250μA, V _{GS} =0V	30			V
I _{DSS}	Zero Gate Voltage Drain Current	V _{DS} =40V, V _{GS} =0V T _J =55°C			1 5	μA
I _{GSS}	Gate-Body leakage current	V _{DS} =0V, V _{GS} =±20V			±100	nA
V _{GS(th)}	Gate Threshold Voltage	V _{DS} =V _{GS} , I _D =25μA	1.7	2.2	3	V
I _{D(ON)}	On state drain current	V _{GS} =10V, V _{DS} =5V	120			A
R _{DS(ON)}	Static Drain-Source On-Resistance	V _{GS} =10V, I _D =10A T _J =125°C		8.2	10	mΩ
		V _{GS} =4.5V, I _D =8A		10	12.5	
g _{FS}	Forward Transconductance	V _{DS} =5V, I _D =10A		75		S
V _{SD}	Diode Forward Voltage	I _S =1A, V _{GS} =0V		0.72	1	V
I _S	Maximum Body-Diode Continuous Current				2.5	A
DYNAMIC PARAMETERS						
C _{iss}	Input Capacitance	V _{GS} =0V, V _{DS} =20V, f=1MHz		1500	1950	pF
C _{oss}	Output Capacitance		215		pF	
C _{rss}	Reverse Transfer Capacitance		135		pF	
R _g	Gate resistance	V _{GS} =0V, V _{DS} =0V, f=1MHz	2	3.5	5	Ω
SWITCHING PARAMETERS						
Q _g (10V)	Total Gate Charge	V _{GS} =10V, V _{DS} =20V, I _D =10A		27.2	37	nC
Q _g (4.5V)	Total Gate Charge		13.6	18	nC	
Q _{gs}	Gate Source Charge		4.5		nC	
Q _{gd}	Gate Drain Charge		6.4		nC	
t _{D(on)}	Turn-On DelayTime	V _{GS} =10V, V _{DS} =20V, R _L = 2Ω, R _{GEN} =3Ω		6.4		ns
t _r	Turn-On Rise Time		17.2		ns	
t _{D(off)}	Turn-Off DelayTime		29.6		ns	
t _f	Turn-Off Fall Time		16.8		ns	
t _{rr}	Body Diode Reverse Recovery Time	I _F =10A, di/dt=100A/μs		30	40	ns
Q _{rr}	Body Diode Reverse Recovery Charge	I _F =10A, di/dt=100A/μs		19		nC



Typical Characteristics

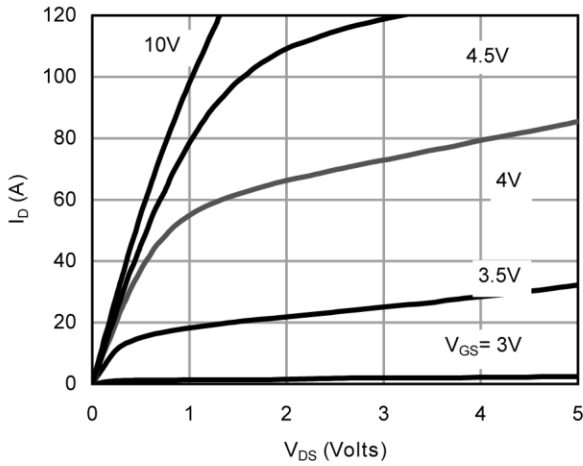

Figure 1: On-Region Characteristics

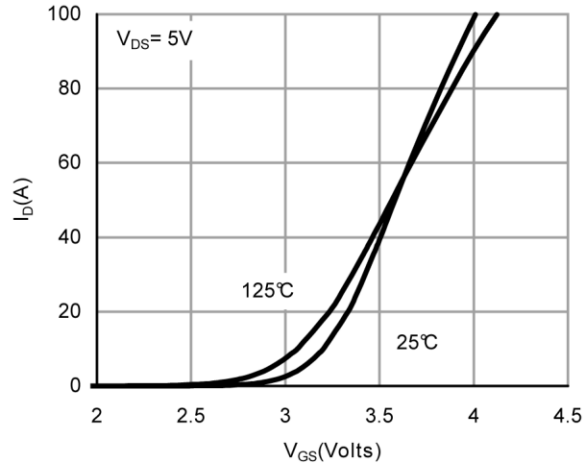

Figure 2: Transfer Characteristics

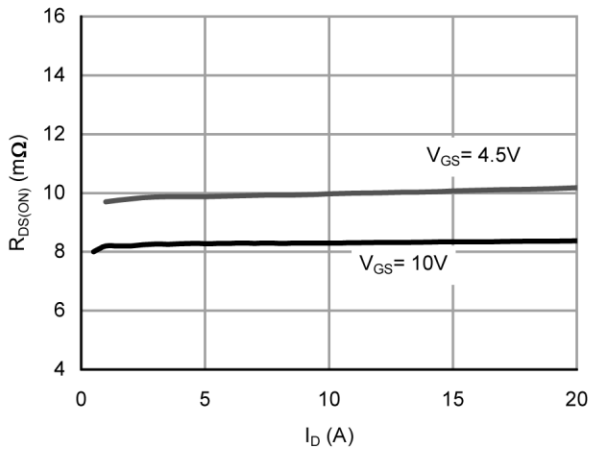

Figure 3: On-Resistance vs. Drain Current and Gate Voltage

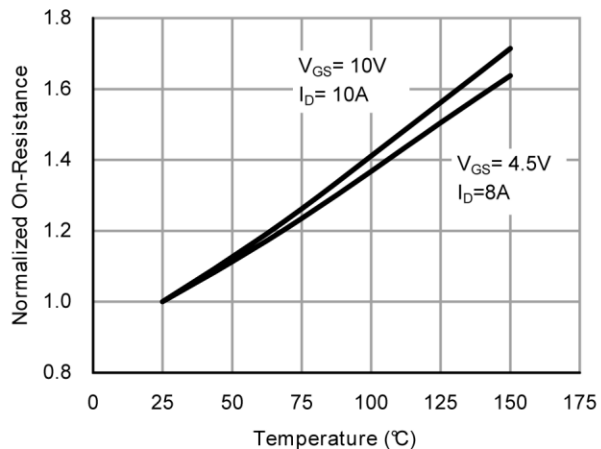

Figure 4: On-Resistance vs. Junction Temperature

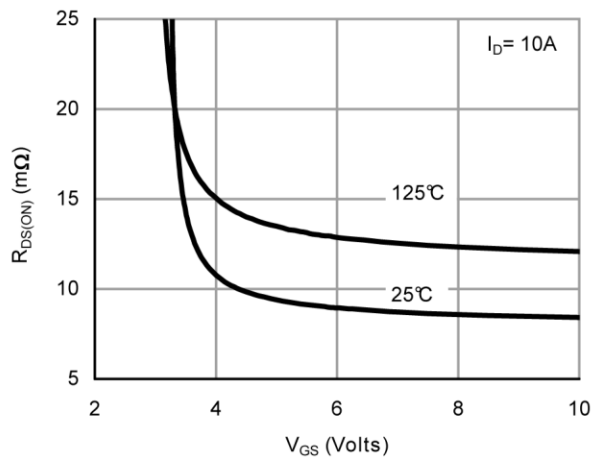

Figure 5: On-Resistance vs. Gate-Source Voltage

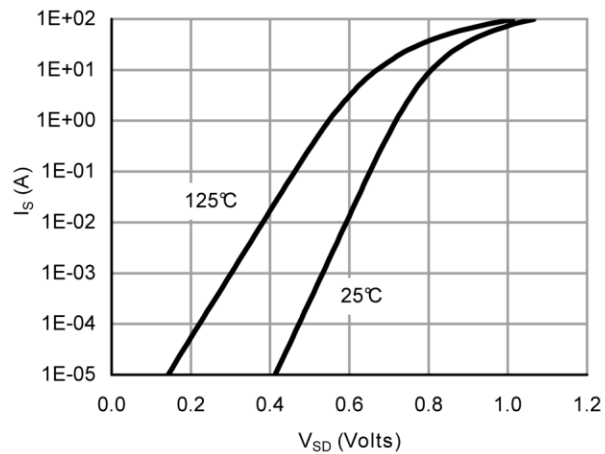

Figure 6: Body-Diode Characteristics

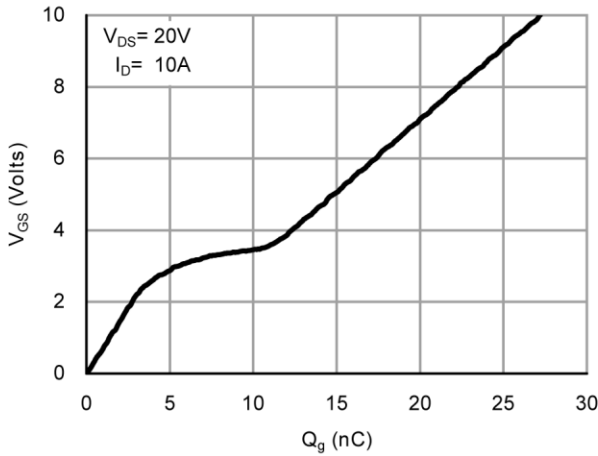

Figure 7: Gate-Charge Characteristics

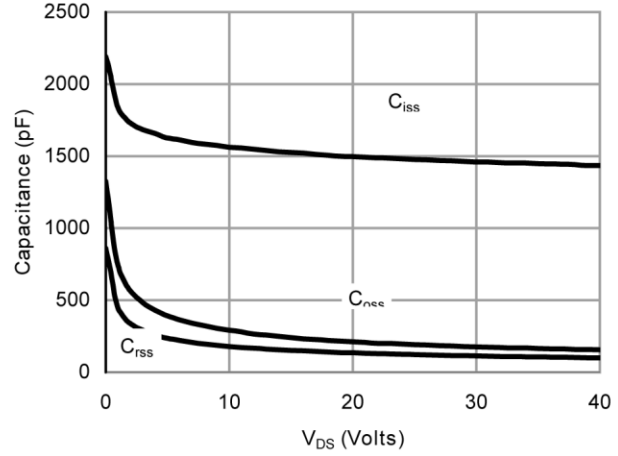

Figure 8: Capacitance Characteristics

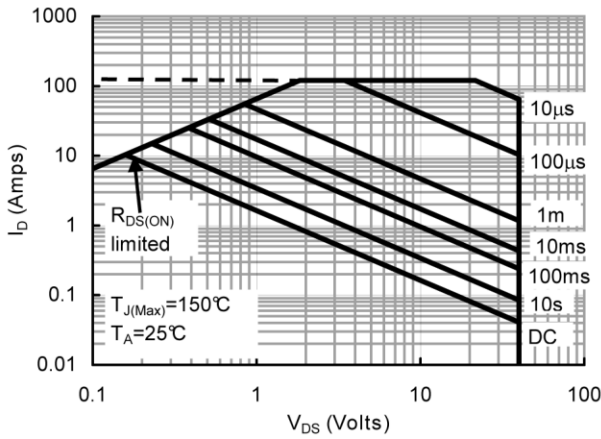

Figure 9: Maximum Forward Biased Safe Operating Area (Note E)

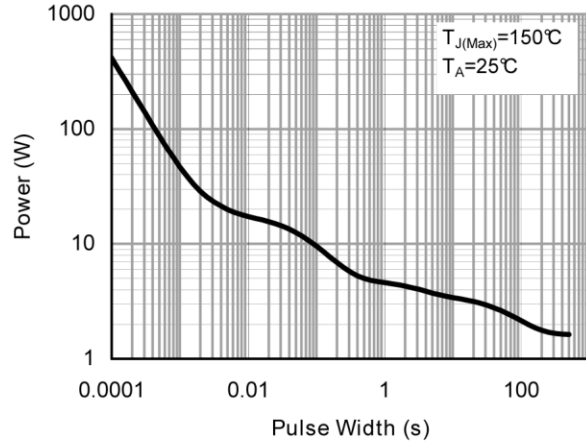

Figure 10: Single Pulse Power Rating Junction-to-Ambient (Note E)

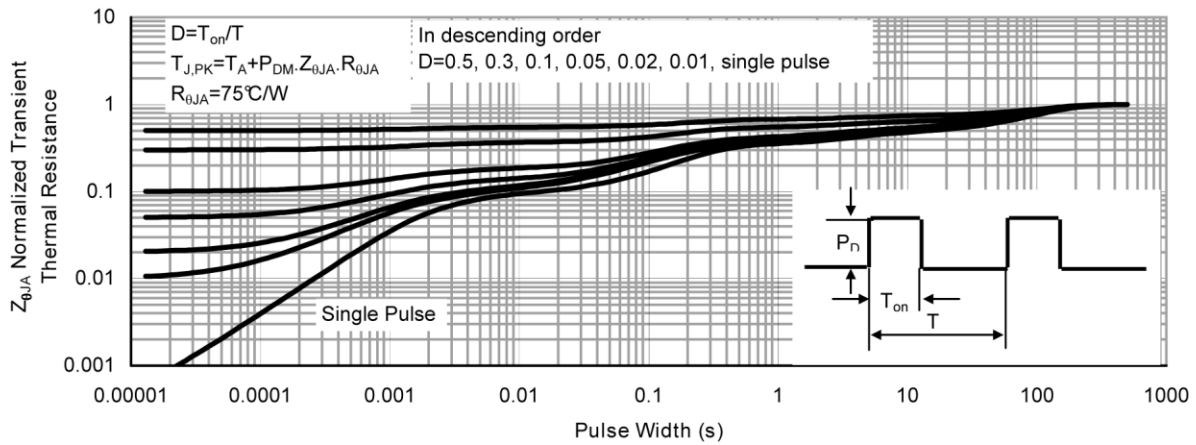
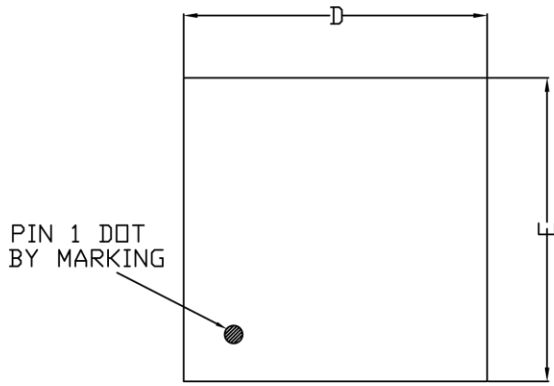

Figure 11: Normalized Maximum Transient Thermal Impedance (Note E)



Packaging Information

DFN-8



TOP VIEW

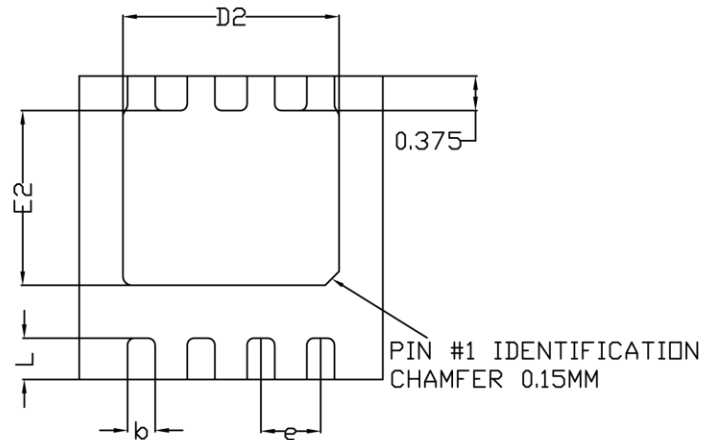

BOTTOM VIEW

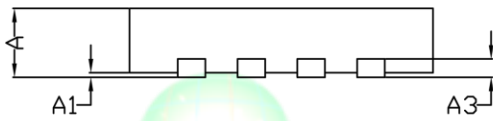

SIDE VIEW

COMMON DIMENSIONS(MM)			
PKG. REF.	UT:ULTRA THIN		
	MIN.	NOM.	MAX
A	0.70	0.75	0.80
A1	0.00	-	0.05
A3	0.20 REF.		
D	3.25	3.30	3.35
E	3.25	3.30	3.35
D2	2.30	2.35	2.40
E2	1.85	1.90	1.95
b	0.25	0.30	0.35
L	0.35	0.45	0.55
e	0.65 BSC		