



Features

- 1µA standby current
- 36V input voltage tolerance
- 6.3V input over-voltage protection
- Linear charger with programmable current
- Constant temperature charge function
- 5.1V synchronous boost output
- 1.2 MHz switching frequency
- 95% efficiency for boost converter
- Active-high enable control
- OCP and OTP for boost output
- ESOP-8 Package

Applications

- TWS earphone charging cases
- Consumer Headsets/Headphones
- Li-ion battery power management

Ordering Information

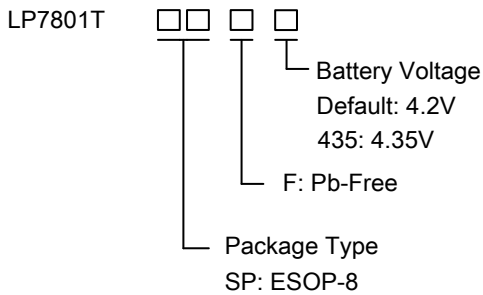

General Description

The LP7801T is a device integrated with a linear charger and a synchronous boost converter.

The linear charger monitors the Li-ion battery status and manages the charging in three phases: trickle current charging, constant current charging and constant voltage charging. Additional features of the linear charger include charging current monitoring, under-voltage lockout, auto-recharge and charging termination indication.

The integrated boost converter features ultra-low quiescent current. It is designed to operate directly from a single-cell Li-ion battery. The output voltage is fixed at 5.1V (Typ.) and the output current is capable of up to 500mA. The boost converter operates typically at 1.2 MHz switching frequency. A 2.2µH inductor is recommended for the converter.

The LP7801T is available in ESOP-8 package.

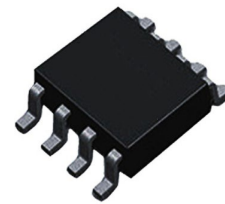

ESOP-8
1.27mm pin pitch

Typical Application Circuit

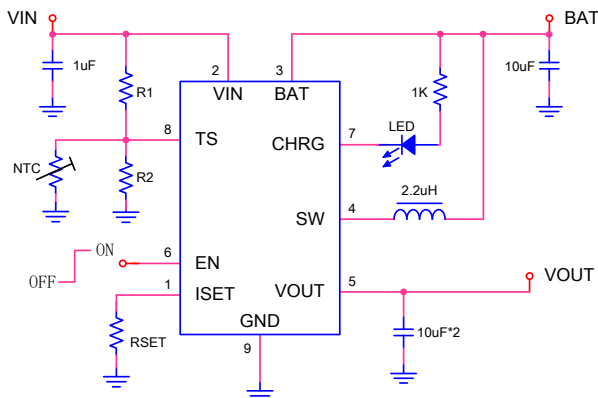

Marking Information

Device	Marking	Package	Shipping
LP7801TSPF	LPS LP7801T YWXXX	ESOP-8	4K/Reel
LP7801TSPF-435	LPS LP7801T 435YWXXX	ESOP-8	4K/Reel

Marking indication:
 Y: Production year
 W: Production week
 X: Series Number



Pin Configuration

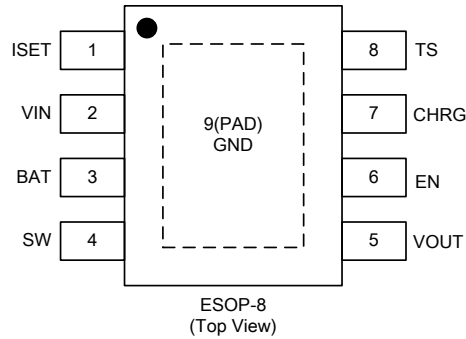

Pin Description

Pin #	Name	Description
1	ISET	Charging current setting pin. A grounded resistor should be connected to this pin to set the constant current charging current (refer to function description for detail).
2	VIN	Linear charger input
3	BAT	Charger output and boost converter input
4	SW	Switching pin for the boost converter
5	VOUT	Boost converter output
6	EN	Enable pin for the boost converter
7	CHRG	Charging status indication pin
8	TS	Temperature detection pin
9	GND	Ground

Functional Block Diagram

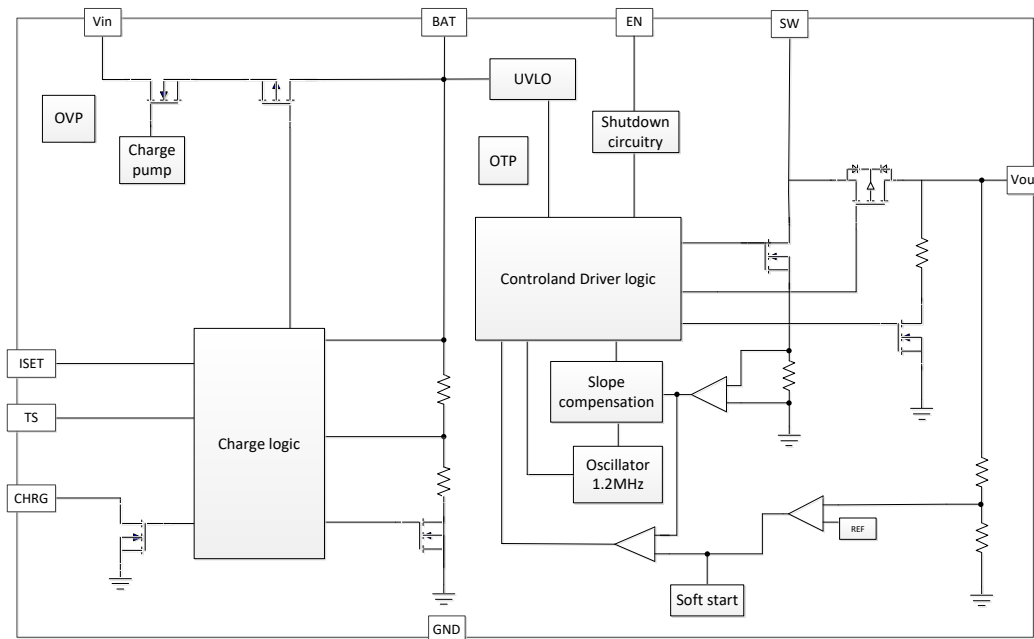



Absolute Maximum Ratings (Note 1)

- VIN to GND ----- -0.3V to +36V
- SW to GND ----- -0.3V to +9V
- VOUT to GND ----- -0.3V to +8V
- Other Pins to GND ----- -0.3V to +6V
- Maximum Junction Temperature (T_J) ----- 150°C
- Maximum Soldering Temperature (at leads, 10 seconds) ----- 260°C
- Storage Temperature ----- -55°C to 150°C

*Note 1: Stresses beyond those listed under “Absolute Maximum Ratings” may cause permanent damage to the device. These are stress ratings only, instead of functional operation of the device at these or any other conditions beyond those indicated in the operational sections of the specifications. Exposure to absolute maximum rating conditions for extended periods may affect device reliability.

Thermal Information

- Maximum Power Dissipation (P_D, T_A ≤ 25°C) ----- 2W
- Thermal Resistance (θ_{JA}) (Note 2) ----- 50°C/W

*Note 2: It is based on 2S2P JEDEC standard PCB.

ESD Ratings

- HBM (Human Body Model, JEDEC JS-001) ----- 2000V
- MM (Machine Model, JESD22-A115C) ----- 200V

Recommended Operating Conditions

Description	Symbol	Min	Max	Unit
Input Voltage	V _{IN}	4.5	5.8	V
Charging Current	I _{BAT}		1	A
Boost Output Current	I _{OUT}		0.5	A
Ambient Temperature	T _A	-20	80	°C

Electrical Characteristics

The following parameters are tested under condition V_{IN} = 5V, T_A = 25°C for typical value, unless otherwise noted.

Parameter	Symbol	Test Conditions	Min	Typ	Max	Unit
-----------	--------	-----------------	-----	-----	-----	------

Charging Part

Input quiescent current	I _{IN}	V _{BAT} = 4.4V		200		μA
Input OVP threshold	V _{OVP}	V _{IN} rising		6.3		V



Parameter	Symbol	Test Conditions	Min	Typ	Max	Unit
Input OVP hysteresis	V _{OVP_HYS}			400		mV
Input UVLO threshold	V _{UVLO}	V _{IN} rising		3.3		V
Charge floating voltage	V _{FLOAT}	LP7801TSPF	4.158	4.20	4.242	V
		LP7801TSPF-435	4.28	4.35	4.375	V
Charging constant current	I _{CC}	R _{ISSET} =17.5 kΩ		100		mA
		R _{ISSET} =3.4 kΩ		515		mA
Battery current (out of device)	I _{BAT_FLOAT}	V _{IN} = 5V, V _{BAT} = 4.2V		1		μA
Battery current (into device)	I _{BAT_LKG}	V _{IN} = 0V, V _{BAT} = 4.2V		1		μA
Trickle charging threshold	V _{TRIKLE}			2.6		V
Trickle charging current	I _{TRIKLE}	V _{BAT} < V _{TRIKLE}		10		%I _{BAT}
Termination threshold	I _{TERM}			10		%I _{BAT}
Battery recharge threshold	ΔV _{RECHG}			150		mV
CHRG output low voltage	V _{OL_CHRG}	I _{CHRG} = 5mA			0.5	V
CHRG leakage current	I _{LKG_CHRG}	V _{BAT} = 4.3V, V _{CHRG} =5V			5	μA
ISET setting voltage	V _{ISET}	V _{TRIKLE} < V _{BAT} < 4.15		1		V
TS low level threshold	V _{TS_L}	TS voltage rising		30		%V _{IN}
TS high level threshold	V _{TS_H}	TS voltage falling		60		%V _{IN}
TS voltage hysteresis	V _{TS_HYS}			30		mV

Discharge Part

Boost output voltage	V _{OUT}			5.1		V
Boost output current	I _{OUT}			500		mA
Boost standby current	I _{BAT}	V _{EN} = 1.4V / floating. No loading.		1		μA
Boost switching frequency	f _{SW}			1.2		MHz
EN input logic high voltage	V _{IH}	Boost enabled when EN voltage higher than this threshold	1.4			V
EN input logic low voltage	V _{IL}	Boost disabled when EN voltage lower than this threshold			0.4	V
EN pin leakage	I _{EN_LKG}	V _{EN} = 5V		0.01		μA
Switch current limit	I _{LIM}			1		A



Parameter	Symbol	Test Conditions	Min	Typ	Max	Unit
High side MOS on-resistance	R _{ON_HIGH}			160		mΩ
Low side MOS on-resistance	R _{ON_LOW}			220		mΩ
Output discharge resistance	R _{DIS}	V _{OUT} = 5V, V _{EN} = 0V		2		kΩ
Thermal shutdown threshold	T _{OTP}			150		°C

Battery Charging Profile

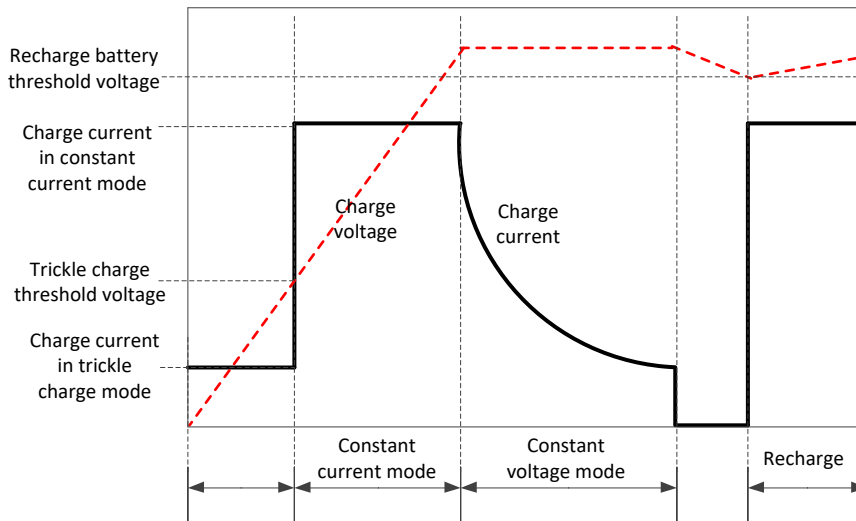

Figure 1. Diagram for typical charging cycle
(red dash curve: Battery Voltage,
black solid curve: Charging current)



Typical Operating Characteristics

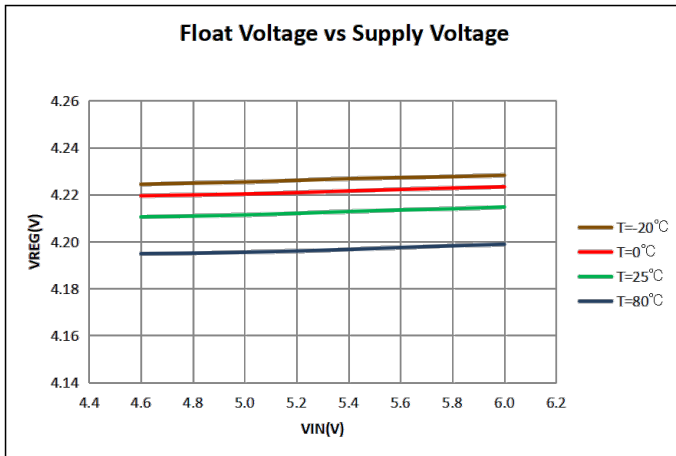

Figure 2. Float Voltage vs Supply Voltage
($C_{IN}=10\mu F$, $C_{OUT}=22\mu F$, $R_{ISET}=16k\Omega$)

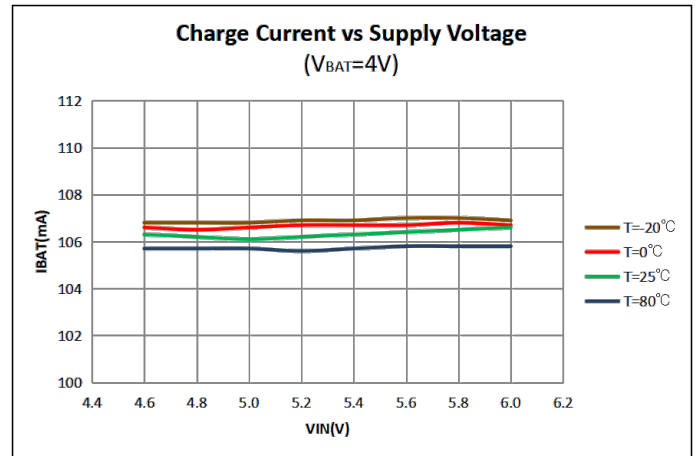

Figure 3. Charge Current vs Supply Voltage
($C_{IN}=10\mu F$, $C_{OUT}=22\mu F$, $R_{ISET}=16k\Omega$)

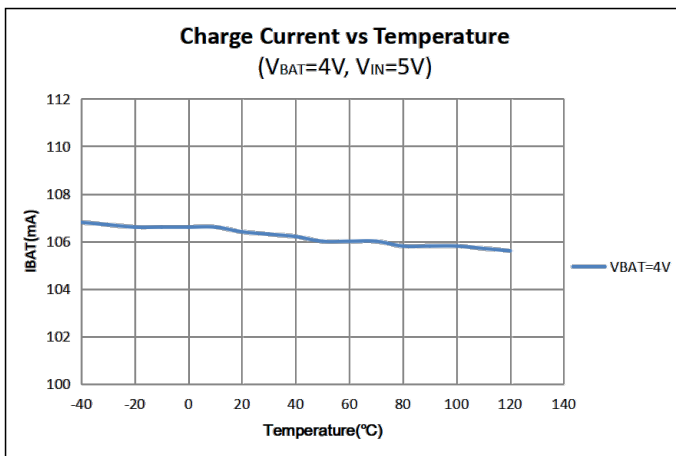

Figure 4. Charge Current vs Supply Voltage
($C_{IN}=10\mu F$, $C_{OUT}=22\mu F$, $R_{ISET}=16k\Omega$)

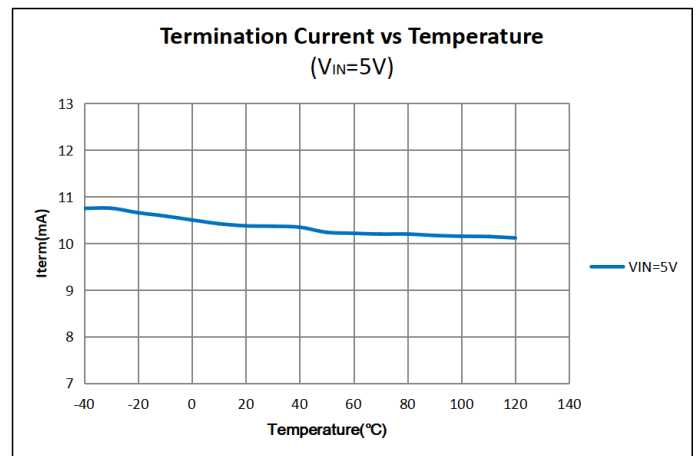

Figure 5. Termination Current vs Temperature
($C_{IN}=10\mu F$, $C_{OUT}=22\mu F$, $R_{ISET}=16k\Omega$)

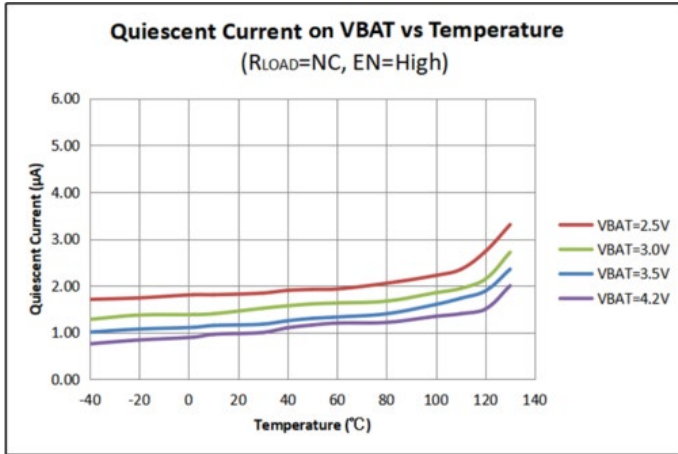

Figure 6. Quiescent Current on VBAT vs Temperature (C_{IN}=10µF, C_{OUT}=22µF, L=2.2µH)

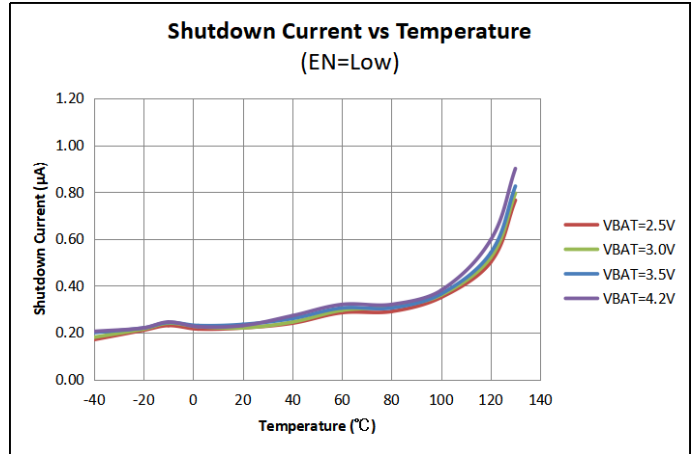

Figure 7. Shutdown Current vs Temperature (C_{IN}=10µF, C_{OUT}=22µF, L=2.2µH)

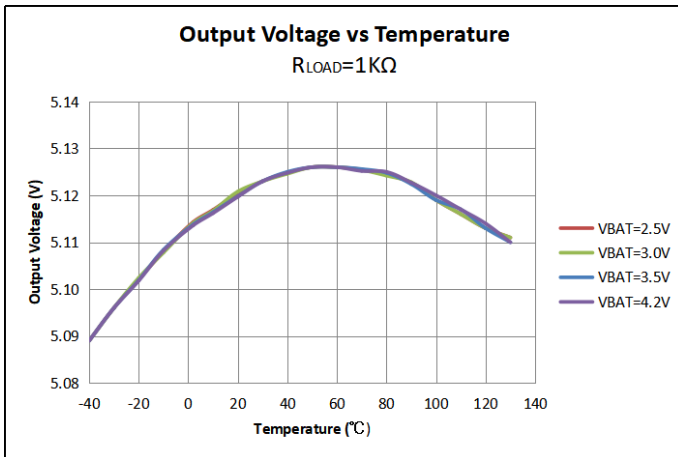

Figure 8. Output Voltage vs Temperature (C_{IN}=10µF, C_{OUT}=22µF, L=2.2µH)

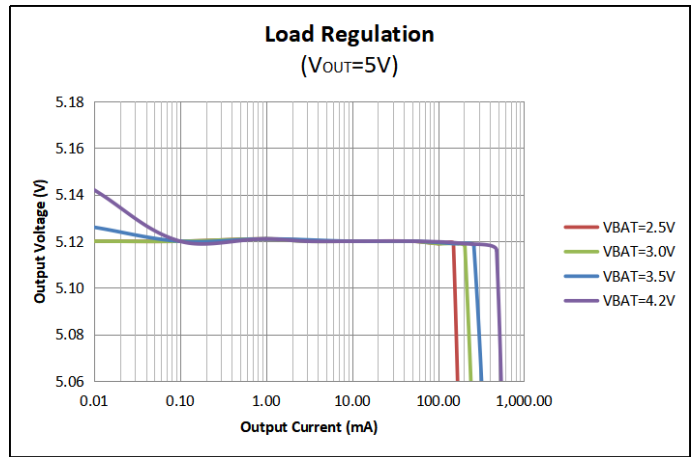

Figure 9. Load Regulation (C_{IN}=10µF, C_{OUT}=22µF, L=2.2µH)

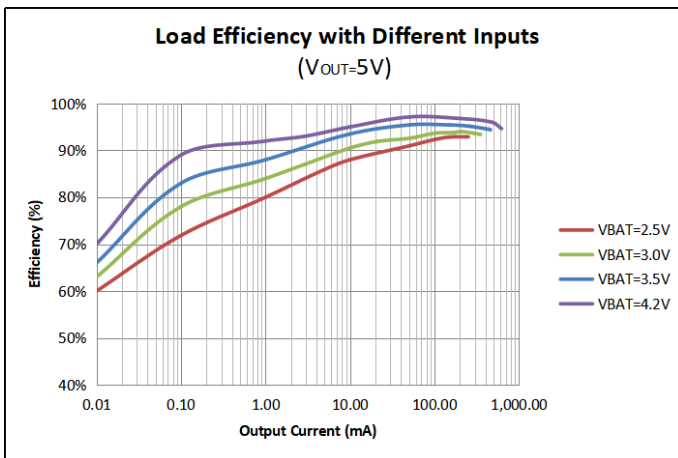

Figure 10. Load Efficiency with Different Inputs (C_{IN}=10µF, C_{OUT}=22µF, L=2.2µH)

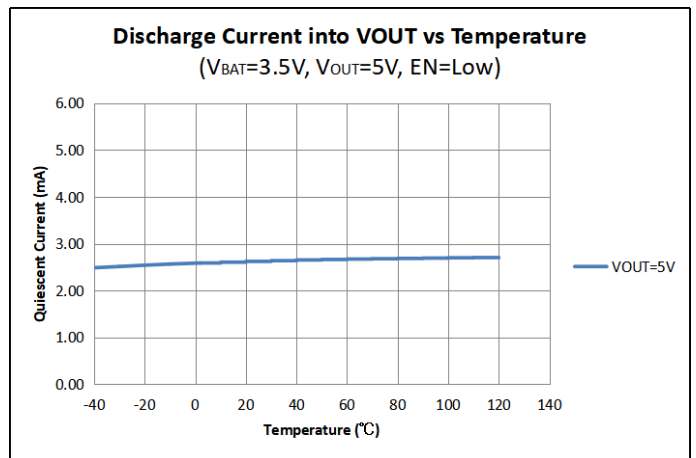

Figure 11. Discharge Current vs Temperature (C_{IN}=10µF, C_{OUT}=22µF, L=2.2µH)



Typical Application Waveforms

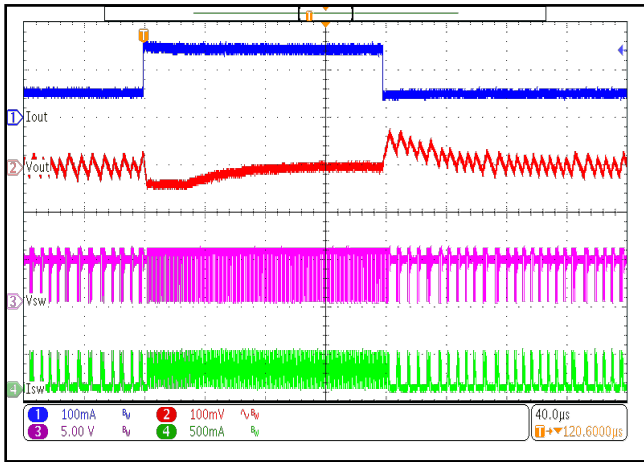

Figure 12. $V_{BAT} = 4.2V$, $I_{OUT} = 50mA$ to $150mA$
($C_{IN}=10\mu F$, $C_{OUT}=22\mu F$, $L=2.2\mu H$)

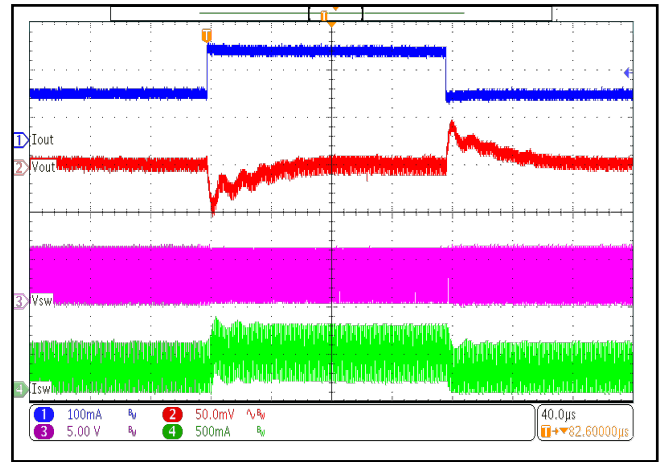

Figure 13. $V_{BAT} = 4.2V$, $I_{OUT} = 100mA$ to $200mA$
($C_{IN}=10\mu F$, $C_{OUT}=22\mu F$, $L=2.2\mu H$)

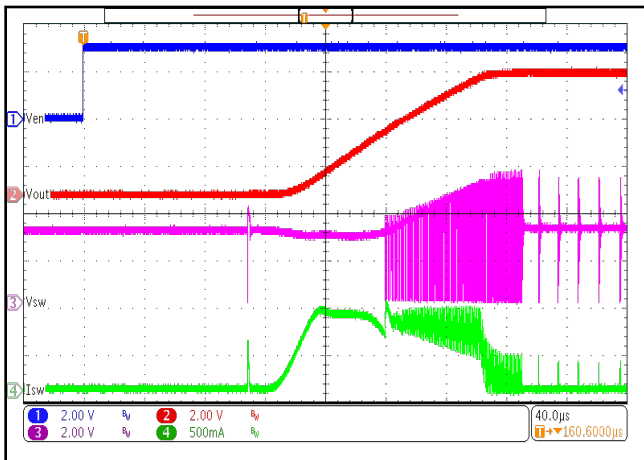

Figure 14. $V_{BAT} = 3V$, No Load
($C_{IN}=10\mu F$, $C_{OUT}=22\mu F$, $L=2.2\mu H$)

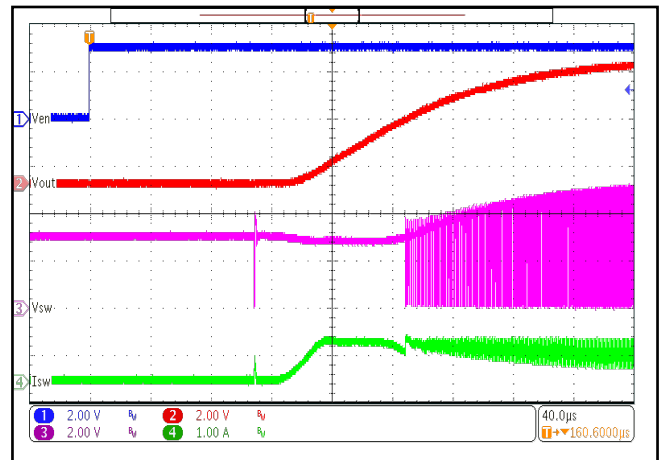

Figure 15. $V_{BAT} = 3V$, $R_{LOAD} = 20\Omega$
($C_{IN}=10\mu F$, $C_{OUT}=22\mu F$, $L=2.2\mu H$)

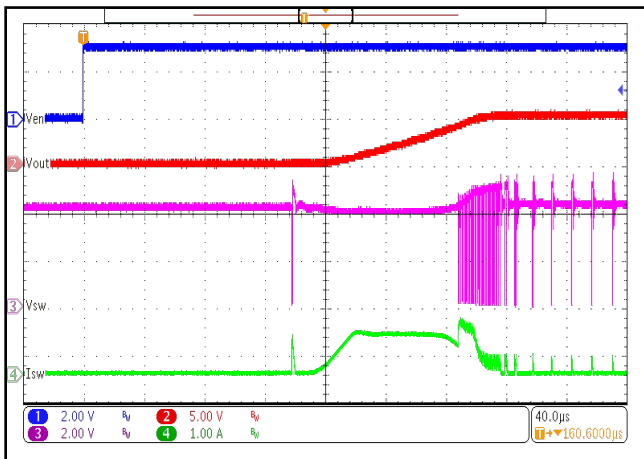

Figure 16. $V_{BAT} = 4.2V$, No Load
($C_{IN}=10\mu F$, $C_{OUT}=22\mu F$, $L=2.2\mu H$)

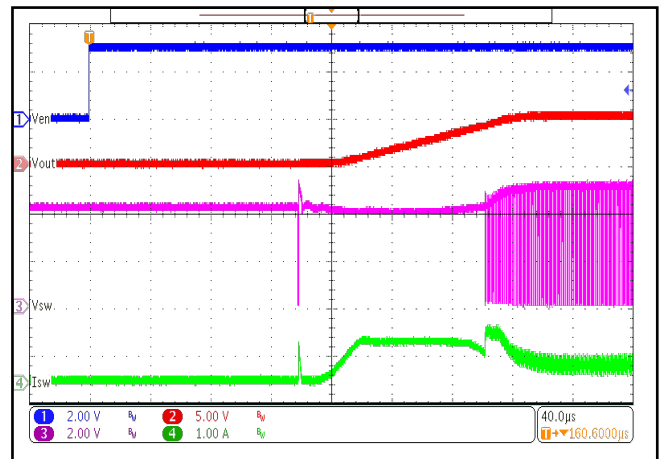

Figure 17. $V_{BAT} = 4.2V$, $R_{LOAD} = 20\Omega$
($C_{IN}=10\mu F$, $C_{OUT}=22\mu F$, $L=2.2\mu H$)

Function Description

Overview

The LP7801T integrates a linear charger and a synchronous boost converter. The charging current is programmable with an external resistor. A TS pin is offered to be connected to an external NTC circuit for thermal protection. The CHRG pin can drive an LED for charging status indication. The boost converter outputs a fixed 5.1V output and can be disabled by pulling the EN pin to low. The boost converter features multiple protections including over-current protection, short-circuit protection, and over-temperature protection.

Charging modes

The linear charger supports trickle charging, constant-current (CC) charging, and constant-voltage (CV) charging modes. The charging current in the CC mode is set via the external resistor R_{ISET} .

$$I_{CC} = 1750 \times \frac{V_{ISET}}{R_{ISET}}$$

where $V_{ISET}=1V$.

When the battery voltage is lower than the trickle charging threshold voltage, the device enters trickle charging mode. The charging current is 1/10 I_{CC} in this mode.

When the battery voltage approaches the floating voltage, the LP7801T enters the CV charging mode. In this mode, the charging current will gradually decrease. When the current decreases below 1/10 I_{CC} , the charging cycle is terminated. A new charging cycle will start automatically when the battery voltage drops below the auto-recharge voltage threshold, $V_{FLOAT} - 0.15V$.

Charging status indication

The LP7801T indicates the charging status through the CHRG pin. The CHRG output has two different states: strong pull-down (~10mA) and high impedance. The strong pulled-down CHRG pin indicates that the charger is in a charging cycle. The high impedance CHRG pin indicates that the charging cycle is terminated. While the input voltage is lower than 4.5V or higher than the OVP protection threshold, the CHRG pin is also in a high-impedance state.

Thermal protection

The LP7801T will monitor the TS pin voltage to realize temperature protection. As shown in the Typical Application Circuit, the external resistors (R_1/R_2) and the NTC resistor should be connected to the TS pin from V_{IN} . The NTC resistance will vary with the temperature. Accordingly, TS pin voltage changes. The LP7801T will compare it with internal references. Charging cycle will only happen when the voltage on TS pin is within V_{TS_L} and V_{TS_H} . Otherwise, the device will stop charging.

The internal references are generated with a resistor divider powered by the V_{IN} pin, same as the TS voltage that is generated by the external resistor ladder. Therefore, this threshold is independent of the V_{IN} -pin voltage.

To design the thermal protection in system, the NTC resistor should be chosen properly. Refer to the Typical Application Circuit, the external resistors R_1 and R_2 can be selected according to following equations:

$$R_1 = \frac{R_{TL}R_{TH}(K_2 - K_1)}{(R_{TL} - R_{TH})K_1K_2}$$

$$R_2 = \frac{R_{TL}R_{TH}(K_2 - K_1)}{R_{TL}(K_1 - K_1K_2) - R_{TH}(K_2 - K_1K_2)}$$

where, $K_1 = V_{TS_L} / V_{IN} = 30\%$, $K_2 = V_{TS_H} / V_{IN} = 60\%$, R_{TL} is the NTC resistance at the low temperature threshold and R_{TH} is the high temperature threshold.

If the thermal protection feature is not needed, same value resistor R_1 and R_2 could be used to keep the TS pin voltage at 50% V_{IN} .

Synchronous boost converter

The boost converter offers the battery discharge path with both the upper and the lower power FETs integrated. The converter operates at 1.2MHz fixed switching frequency and outputs a fixed 5.1V voltage at light load. The maximum supported output current is 500mA. A 2.2μH inductor and two 10μF ceramic capacitors are recommended, as shown in the Typical Application Circuit.

The EN pin enables or disables the boost converter. When the EN pin is left floating or pulled above the EN pin logic high voltage listed in the Electrical Characteristics table, the boost converter is enabled. The quiescent current is 1μA. When the EN pin is pulled low, the boost converter is disabled and the output will be discharged through a 2kΩ output discharge resistor to 0V.



PCB Layout Guidelines

The printed-circuit-board (PCB) layout is important to have high performance of the LP7801T. Following recommendation in PCB design might help to achieve better layout:

1. The power traces, including the VIN, BAT, SW and GND should be kept short, directly connected and wide to allow large current to flow.
2. The capacitor C_{IN} and C_{BAT} should be placed as close as possible to VIN, BAT and GND to get good power filtering performance.
3. The inductor should be placed as close as possible to SW pin and keep the connection short. There should not be any signal trace under the inductor.
4. The resistance of the trace from the load return to GND should be kept to minimum. This will help to minimize any error in DC regulation due to difference in the potential between the internal signal ground and the external power ground.



Package Information

ESOP-8

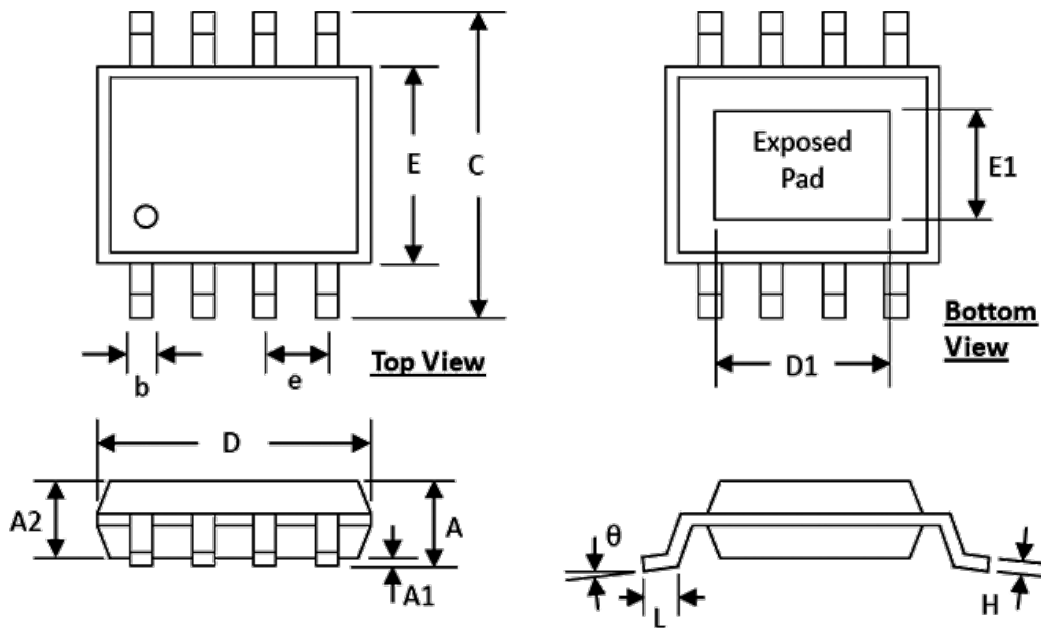

SYMBOLS	DIMENSION (MM)		DIMENSION (INCH)	
	MIN	MAX	MIN	MAX
A	1.30	1.70	0.051	0.067
A1	0.00	0.15	0.000	0.006
A2	1.25	1.52	0.049	0.060
b	0.33	0.51	0.013	0.020
C	5.80	6.20	0.228	0.244
D	4.80	5.00	0.189	0.197
D1	3.15	3.45	0.124	0.136
E	3.80	4.00	0.150	0.157
E1	2.26	2.56	0.089	0.101
e	1.27 BSC		0.050 BSC	
H	0.19	0.25	0.0075	0.0098
L	0.41	1.27	0.016	0.050
θ	0°	8°	0°	8°