



Features

- 0.5% Charge Voltage Accuracy
- 3A Maximum Charge Current
- Up to 92% Efficiency
- Dynamic Power Management for Different Input Source Capacity Application
- No External MOSFETs and Reverse-Blocking Diode Required
- Trickle Current/Constant Current/Constant Voltage Mode Supported
- Charge Termination and Automatic Recharge
- Maximum Input Voltage up to 28V with 7V Input-Over-Voltage Protection
- Battery Under/Over Temperature Protection
- Junction Over Temperature Protection
- Cycle-by-Cycle Current-Limit Protection
- ESD Protection
- Package: 3x3mm DFN-10

Applications

- Portable Media Players
- Cellular and Smart Mobile Phone
- Handheld Battery-Powered Devices
- Charging Docks and Cradles

Order Information

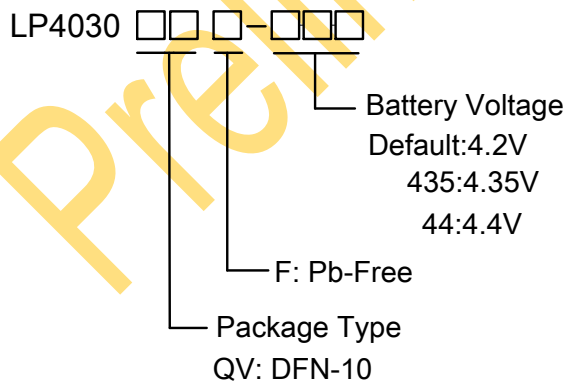

General Description

The LP4030 device is a highly-integrated switching charger for single cell Li-Ion and Li-Polymer battery. The device includes dual integrated N-channel power MOSFETs and a constant-frequency synchronous PWM controller.

The device supports charge current up to 3A and can withstand an input voltage up to 28V. The device is disabled while the input voltage exceeds the input over-voltage-protection threshold. The BAT pin can withstand a voltage up to 24V, which is designed for protecting the device from an over-shoot voltage in battery application systems.

The device provides various safety features for battery charging, including battery under/over temperature protection by an NTC monitoring circuit, device junction over temperature protection and cycle-by-cycle inductor current-limit protection. There is an input voltage regulation loop for dynamic power management by reducing the charge current when the input source current capacity is lower than the programmed charge current. The STAT output indicates the charging status. The LP4030 is available in a DFN-10 (3x3mm) package.



DFN-10



Marking Information

Part Number	Top Marking	Battery Voltage	Package	Shipping
LP4030QVF	LPS LP4030 YWX	4.2V	DFN-10	5K/REEL
LP4030QVF-435	LPS LP4030 435YWX	4.35V	DFN-10	5K/REEL
LP4030QVF-44	LPS LP4030 44YWX	4.4V	DFN-10	5K/REEL

Marking indication:

LPS : LPS prefix.

LP4030 : Product code of LP4030QVF.

435/44 : Battery Voltage.

Y: Year code.

W: Week code.

X: Batch numbers.

Typical Application Circuit

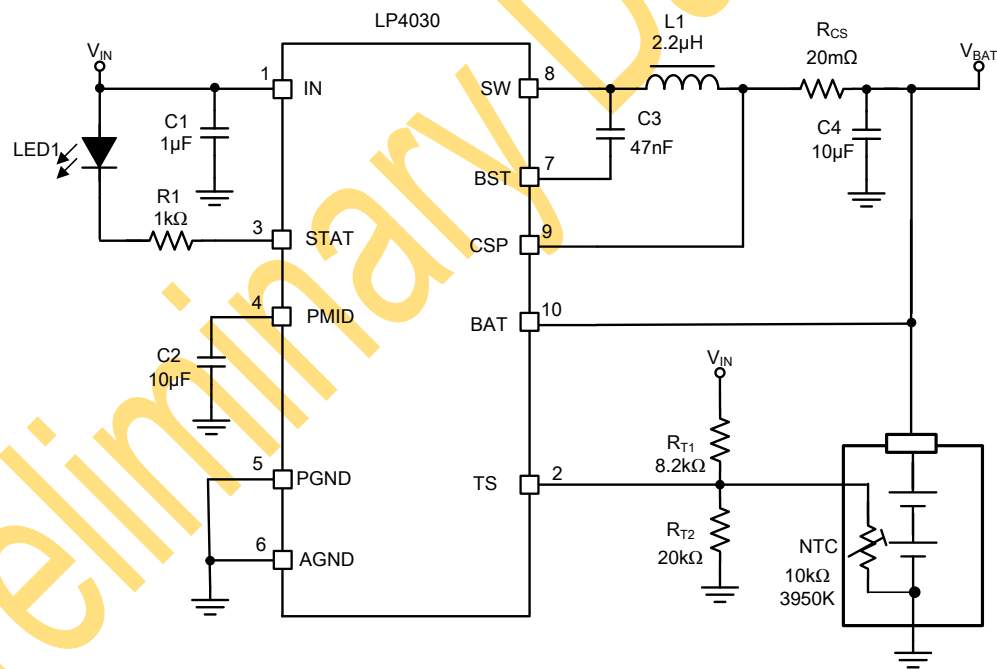



Pin Diagram

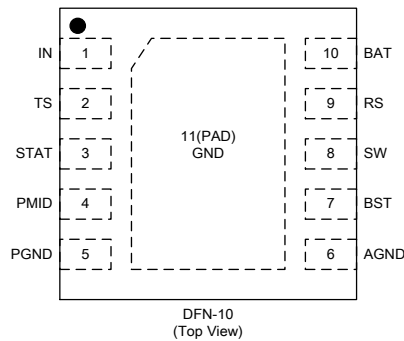

DFN-10 (Top View)

Pin Description

Pin	Name	Description
1	IN	Positive Supply Voltage Input. Place a 1 μ F ceramic capacitor from IN to PGND and place the capacitor as close as possible to IC.
2	TS	Battery Temperature Sense Thermistor Input. This pin senses the temperature of the battery pack and charge is suspended if the battery temperature is out of range.
3	STAT	Open-Drain Charge Status Output. When the battery is charging, this pin is pulled down to GND by an internal N-channel MOSFET. While the charge is complete, STAT pin is in high impedance.
4	PMID	Power MOSFET Input. Connect this pin with a 10 μ F ceramic capacitor to ground and place it as close as possible to IC.
5	PGND	Power Ground.
6	AGND	Analog Ground.
7	BST	High-side MOSFET Driver Supply Input. BST is internally connected to the cathode of the internal boost-strap diode. Connect 47nF bootstrap capacitor from BST to SW.
8	SW	Switching Node. Internally SW is connected to the source of the n-channel HSFET and the drain of the N-channel LSFET. Connect this pin to external inductor.
9	CSP	Charge Current Sensing Positive Input. Connect this pin to external current sensing resistor Rcs.
10	BAT	Battery Voltage Sensing and Charge Current Sensing Negative Input. Connect this pin to the positive terminal of the battery pack. 10 μ F ceramic capacitor is recommended to connect from this pin to PGND.
11	PAD	Ground reference for the device that is also the thermal pad used to conduct heat from the device.



Functional Block Diagram

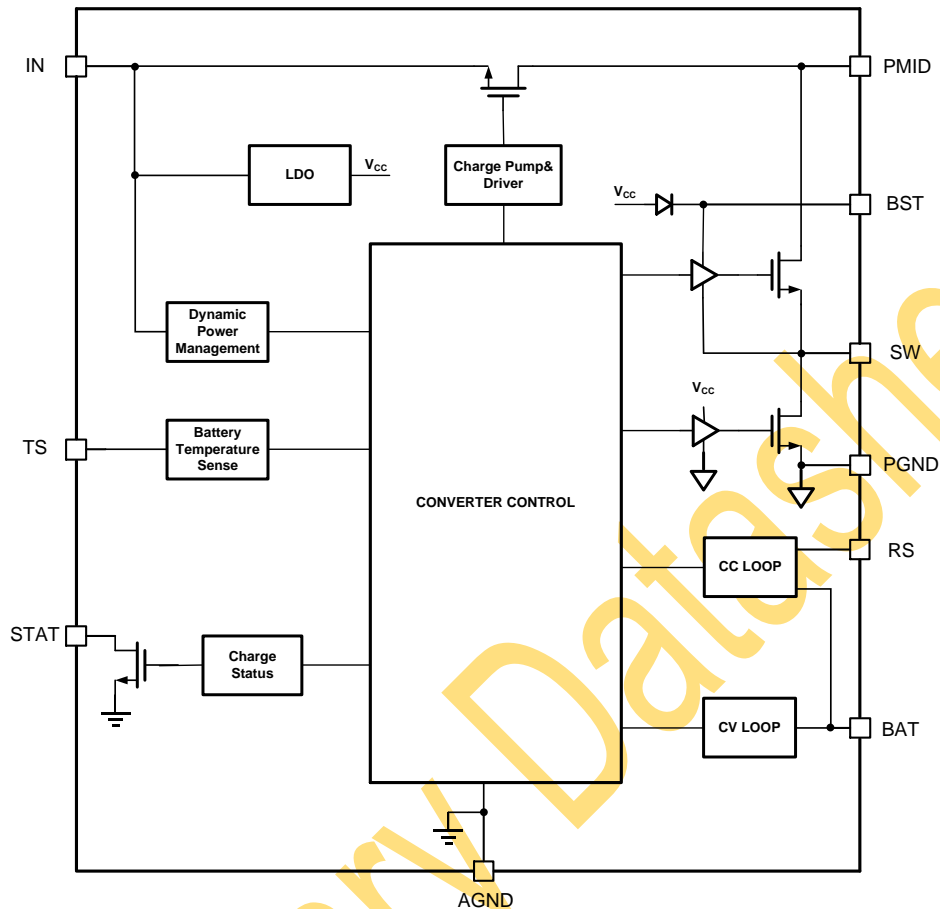

Absolute Maximum Ratings (Note 1)

- IN/PMID/SW to GND ----- -0.3V to 28V
- STAT/CHRG/BAT/RS/TS to GND ----- -0.3V to 24V
- BST to SW ----- -0.3V to 6V
- Maximum Junction Temperature (T_J) ----- 150°C
- Operating Ambient Temperature Range (T_A) ----- -40°C to 85°C
- Maximum Soldering Temperature (at leads, 10 sec) ----- 260°C

Note 1. Stresses beyond those listed under “Absolute Maximum Ratings” may cause permanent damage to the device. These are stress ratings only, and functional operation of the device at these or any other conditions beyond those indicated in the operational sections of the specifications is not implied. Exposure to absolute maximum rating conditions for extended periods may affect device reliability.

ESD Susceptibility

- HBM(Human Body Model) ----- 2KV
- MM(Machine Model) ----- 200V



Recommended Operating Conditions

- Input Voltage ----- 4.5V to 6.0V
- Maximum Charge Current ----- 3.0A
- Operating Junction Temperature Range (T_J) ----- -40°C to 150°C
- Ambient Temperature Range ----- -40°C to 85°C

Electrical Characteristics

(The specifications are at T_A=25°C, V_{IN} = 5V, unless otherwise noted.)

Symbol	Parameter	Condition	Min	Typ	Max	Units
V _{IN}	Input Voltage Range		4.5		6	V
I _{CC}	Input Supply Current	Standby Mode (Charge Terminated)		500		μA
V _{UVLO}	Under Voltage Lockout of IN	V _{IN} Rising		3.9		V
V _{UVLO_HYS}	V _{UVLO} Hysteresis	V _{IN} Falling		150		mV
V _{OVP}	Over-Voltage Protection Threshold Voltage	V _{IN} Rising		7		V
V _{OVP_HYS}	OVP Hysteresis Voltage	V _{IN} Falling		500		mV
V _{DPM_THR}	Input Dynamic Power Management Threshold Voltage	Charge Current < I _{BAT} in Constant Current Mode		4.4		V
V _{FLOAT}	Regulated Output (Float) Voltage	LP4030QVF	-0.5%	4.207	0.5%	V
		LP4030QVF-435		4.35		V
		LP4030QVF-44		4.4		V
V _{CS}	RS to BAT Reference Voltage (Program Charge Current)	V _{TRIKL} < V _{BAT} < V _{FLOAT}	48	51	54	mV
I _{BAT}	Constant Charge Current	R _{CS} =50mΩ, Constant Current Mode		1020		mA
		R _{CS} =25mΩ, Constant Current Mode		2040		mA
		After Terminated, V _{IN} =5V V _{BAT} =4.35V		-2.2		μA
I _{LEAK}	Leakage Current	V _{IN} =0V, V _{BAT} =4.35V		-1.7		μA
I _{TRIKL}	Trickle Charge Current	V _{BAT} < V _{TRIKL} , R _{CS} =50mΩ		100		mA



V_{TRIKL}	Trickle Charge Threshold Voltage	$R_{CS}=50m\Omega$, V_{BAT} Rising	2.8	V
V_{TRHYS}	Trickle Charge Hysteresis Voltage	$R_{CS}=50m\Omega$	170	mV
V_{STAT}	STAT Pin Output Low Voltage	$I_{STAT}=5mA$	0.5	V
V_{RECHRG}	Battery Recharge Threshold Voltage	V_{RECHRG}	4.20	V
T_{J_THR}	Junction Over Temperature Protection Threshold	Temperature Rising	150	$^{\circ}C$
T_{J_HYS}	T_{J_THR} Hysteresis	Temperature Falling	30	$^{\circ}C$
I_{TERM}	Terminal Current	$R_{CS}=50m\Omega$	100	mA
F_{SW}	Switching Frequency	$V_{IN}=5V$, $R_{CS}=50m\Omega$	530	kHz
I_{MOS_LIM}	Switch MOSFET Current Limit		4.5	A
R_{IN_PMID}	IN-PMID MOSFET on-resistance	$V_{IN}=5V$, $R_{CS}=50m\Omega$	50	$m\Omega$
R_{PMID_SW}	PMID-SW MOSFET on-resistance	$V_{IN}=5V$, $R_{CS}=50m\Omega$	50	$m\Omega$
R_{SW_GND}	SW-GND MOSFET on-resistance	$V_{IN}=5V$, $R_{CS}=50m\Omega$	50	$m\Omega$
V_{NTC_H}	NTC threshold Voltage, Hot		$0.3*V_{in}$	V
V_{NTC_C}	NTC threshold Voltage, Cold		$0.6*V_{in}$	V



Typical Characteristics

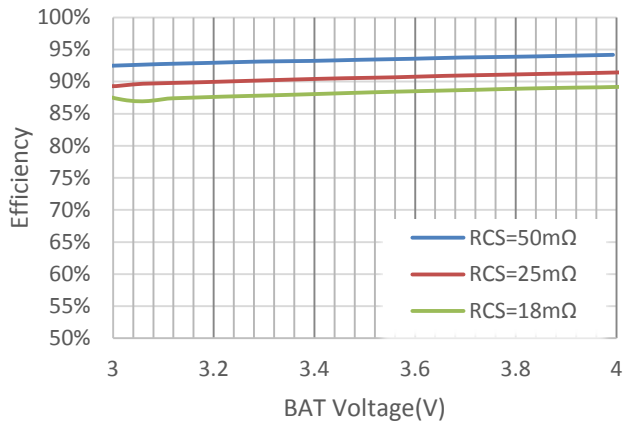

Figure 1. Constant current mode Efficiency
 $V_{IN}=5V, 25C^{\circ}$

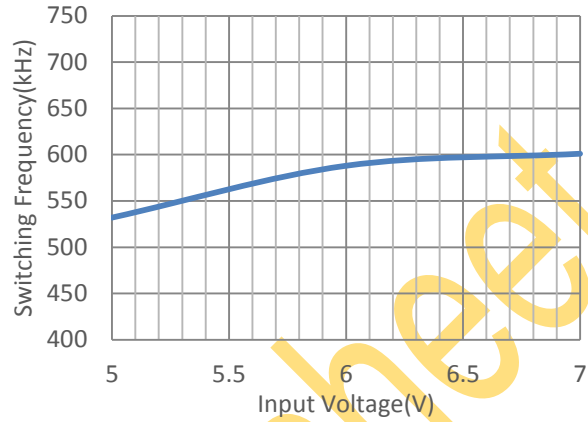

Figure 2. Switching Frequency vs V_{IN}
 $V_{BAT}=3.5V, R_{CS}=25m\Omega, 25C^{\circ}$

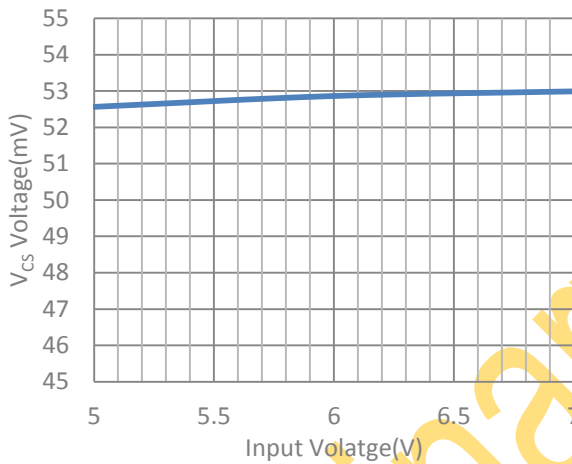

Figure 3. Constant Current mode V_{CS} Voltage vs V_{IN}
 $V_{BAT}=3.5V, R_{CS}=25m\Omega, 25C^{\circ}$

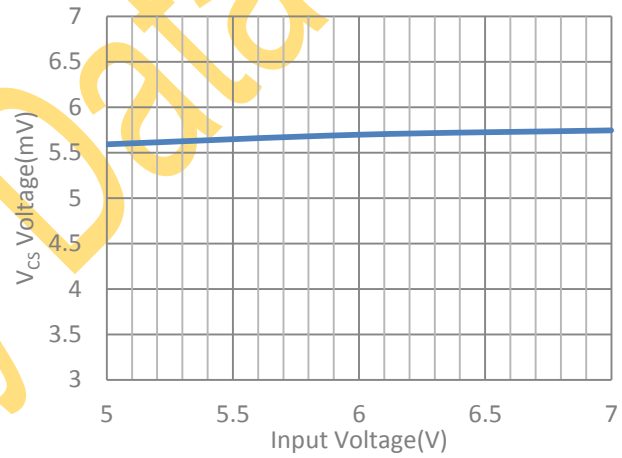

Figure 4. Trickle Current mode V_{CS} Voltage vs V_{IN}
 $V_{BAT}=2V, R_{CS}=25m\Omega, 25C^{\circ}$

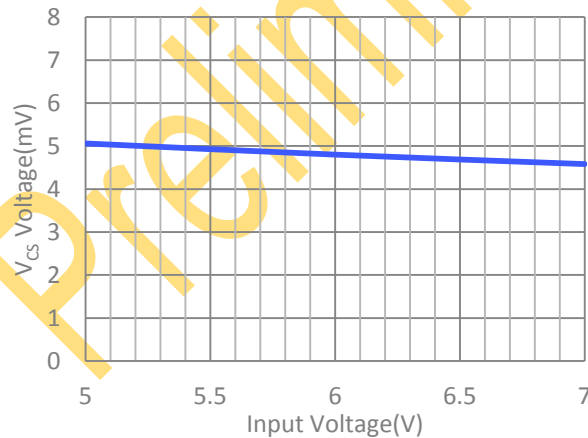

Figure 5. Terminate V_{CS} Voltage vs V_{IN}
 $V_{BAT}=2V, R_{CS}=25m\Omega, 25C^{\circ}$



Detailed Description

Overview

The LP4030 device is a highly-integrated switching charger with up to 3A maximum charge current for single cell Li-Ion and Li-Polymer battery. The device charges the battery in three modes: trickle current mode, constant current mode and constant voltage mode.

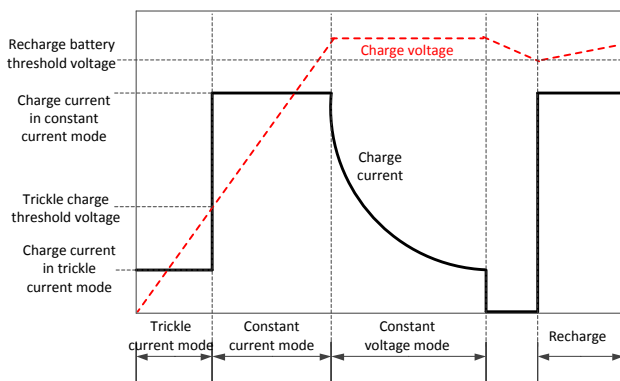

Figure 6. Typical Charge Profile

When the battery voltage lower than trickle charge threshold voltage 2.8V (typical), the device is in trickle current mode, the charge current will be set as 10% of that in constant current mode.

When the battery voltage increases to be higher than trickle charge threshold voltage, the device enters the constant current mode, the constant charge current is set by the external sense resistor R_{CS} and an internal reference voltage V_{CS} , the equation showed as below:

$$I_{BAT} = \frac{V_{CS}}{R_{CS}}$$

When the battery voltage approaches the programmed float voltage, it goes to constant voltage mode, the charge current will start to decrease. When the charge current drops down to 10% of that in constant current mode, the device will terminate the charging. The

device will automatically recharge the battery while the battery voltage is lower than the recharge threshold voltage.

Shutdown

The LP4030 device will be shut down by connecting a pull up resistor between the TS pin and IN pin. In shutdown mode, the STAT pin to GND keeps high impedance. If the voltage at the IN pin drops below $(V_{BAT}+150mV)$ or below the UVLO level, the LP4030 device goes into a low current sleep mode with no charging, the IN pin provides the power to the device internal circuit for reducing the discharging current from the battery to the device.

Automatic Recharge

Once the charge cycle is terminated, the LP4030 device continuously monitors the voltage on the BAT pin by a comparator with a 1.8ms filter. A new charge cycle restarts when the battery voltage falls below the recharge threshold voltage 4.20V (typical, which corresponds to approximately 80% to 90% battery capacity). This ensures that the battery always keeps at or near a fully charged condition.

Battery Temperature Detection

The LP4030 device continuously monitors the battery temperature by measuring the voltage between the TS pin and AGND pin. The device compares V_{TS} to its internal thresholds V_{NTC_H} and V_{NTC_C} , and then determine whether charging is allowed. The temperature sensing circuit is immune to any fluctuation in V_{IN} because both the external voltage divider and the internal thresholds (V_{NTC_H} and V_{NTC_C})



are referenced to V_{IN} .

The resistor values of R_{T1} and R_{T2} are calculated by the following equations:

For NTC Thermistors:

$$R_{T1} = \frac{R_{TL}R_{TH}(K_2 - K_1)}{(R_{TL} - R_{TH})K_1K_2}$$

$$R_{T2} = \frac{R_{TL}R_{TH}(K_2 - K_1)}{R_{TL}(K_1 - K_1K_2) - R_{TH}(K_2 - K_1K_2)}$$

For PTC Thermistors:

$$R_{T1} = \frac{R_{TL}R_{TH}(K_2 - K_1)}{(R_{TH} - R_{TL})K_1K_2}$$

$$R_{T2} = \frac{R_{TL}R_{TH}(K_2 - K_1)}{R_{TH}(K_1 - K_1K_2) - R_{TL}(K_2 - K_1K_2)}$$

$K_{1(VTS_H)}=30\%$, $K_{2(VTS_C)}=60\%$.

Where R_{TL} is the low temperature resistance and R_{TH} is the high temperature resistance of thermistor, as specified by the thermistor manufacturer.

Application Information

Inductor Selection

Because the selection of inductor affects charger's steady state operation, transient behavior, loop stability and the charger's efficiency, the inductor is one of the most important components in the application design. There are three specifications most important to the performance of the inductor: inductor value, DC resistance, and saturation current. For the LP4030 device applications, a 2.2 ~4.7μH inductor is typically available. Therefore, customers need to verify the inductor in their application if it is different from the values in typical application circuit. Inductor values can have ±20% or even ±30% tolerance with no current

Junction Over Temperature Protection

When the internal junction temperature of LP4030 exceeds the junction over temperature protection threshold 150°C, the device stops the charging, after the junction temperature falls down to lower than 120°C, the charging cycle will be resume.

Dynamic Power Management

For different input capacity source application, the LP4030 device integrates an input current adaptive function. When the input voltage falls below the input dynamic power management threshold voltage V_{DPM_THR} as the input source current capacity is not enough to offer the programmed charge current, the device begins to reduce the charge current until the input voltage rising up to about V_{DPM_THR} . When the charge current decreases to zero, but the input voltage is still lower than the V_{DPM_THR} , the device keeps in charge status but has no charge current.

bias. When the inductor current approaches saturation level, its inductance can decrease 20% to 35% from the 0A value depending on how the inductor vendor defines saturation. When selecting an inductor, please make sure its rated current, especially the saturation current, is larger than its peak current during the operation. To calculate the inductor peak current in the worst case, customers need take consideration of the maximum input voltage, half-input battery voltage and maximum charging current of the application. In order to leave enough design margin, the inductor value with -30% tolerance is recommended for the calculation. In a buck switching charger, the inductor maximum DC



current should be the charging current in constant current mode. The inductor peak current can be calculated as below:

$$\Delta I_{PP} = \frac{(V_{IN} - V_{BAT}) * V_{BAT}}{V_{IN} * F_{SW}} * \frac{1}{L}$$
$$I_{L_PK} = I_{BAT} + \frac{\Delta I_{PP}}{2}$$

Buck switching charger efficiency is dependent on the resistance of its current path, the switching losses associated with the switch MOSFET and the inductor's loss. The inductor's loss is affected a lot by the inductor's DC Resistance (DCR), Equivalent Series Resistance (ESR) at the switching frequency and the core loss. Core loss is related to the core material and different inductors have different core loss. For a certain inductor, larger current ripple generates higher DCR/ESR conduction losses as well as higher core loss. Normally a datasheet of an inductor does not provide the ESR and core loss information. If needed, consult the inductor vendor for detailed information. Generally, an inductor with lower DCR/ESR is recommended for the LP4030 device application.

Layout Consideration

As for switching charger, especially providing high current and using high switching frequencies, layout is an important design step. If layout is not carefully done, the charger could show instability as well as EMI problems. Here is a PCB layout priority list for proper layout.

1. Place capacitor C1 as close as possible to IN pin and PGND pin.
2. Place capacitor C2 as close as possible to PMID pin and PGND pin.
3. Use single-point connection to connect charger power ground to device analog ground.
4. Place inductor input terminal to SW pin as close as possible. Minimize the copper area of this trace to lower electrical and magnetic field radiation but make the trace wide enough to carry the charge current.
5. The via size and number should be enough for a given current path.
6. Place the C3 as close as possible to the BST pin.
7. Place the wire of RS and BAT close and parallel to each other as charge current sense, and also keep the wire close to the device.

Preliminary Datasheet



Packaging Information

DFN-10

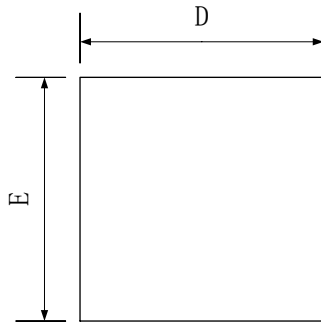

TOP VIEW

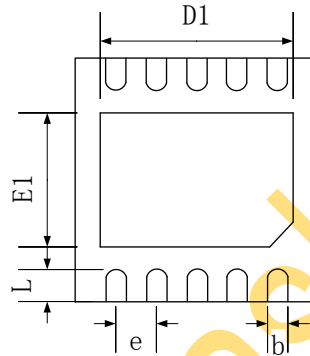

BOTTOM VIEW

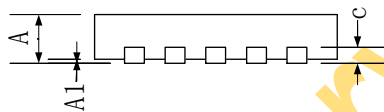

SIDE VIEW

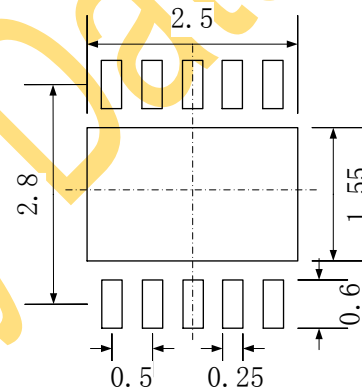

Recommended Land Pattern

SYMBOL	MILLIMETER		
	MIN	NOM	MAX
A	0.70	0.75	0.80
A1	0.00	0.02	0.05
b	0.18	0.25	0.30
C	0.20 REF		
D	2.90	3.00	3.10
D1	2.40	2.50	2.60
E	2.90	3.00	3.10
E1	1.45	1.55	1.65
e	0.50 BSC		
L	0.30	0.40	0.50